

Certificate of Accreditation

Sewage Management Facility

Septic Tank / Collection Well

This Certificate of Accreditation is issued by the Secretary of the NSW Ministry of Health pursuant to Section 41(1) Local Government (General) Regulation 2021.

Manufacturer: Central Coast Septics Pty Ltd

Of: 5 Marklea Close, Tuggerah, NSW, 2259

The CCS Septic Tank / Collection Well range as described in the following schedule, have been accredited as Sewage Management Facilities for use in single domestic premises in NSW. The Septic Tanks and Collection Wells have been independently certified as being manufactured to Australian / New Zealand Standard "AS/NZS1546.1:2008 On-site domestic wastewater treatment units – Part 1: Septic tanks".



Director, Environmental Health

For Secretary (Delegation PH335)

Issued: 30106125

Certificate Number: STCW015

Expires 31 December 2030

Accreditation Schedule

The Certificate of Accreditation applies to the following
Septic Tanks / Collection Wells

Model	Description	Size
Septic Tank	Vertical axis type precast concrete with steel reinforcing mesh with lid, partition, access cover, inlet and outlet fittings. Burial depth of the tank lid is restricted to 0 mm	2300 L 2800 L 4000 L 7100 L
Collection Well	Vertical axis type precast concrete with steel reinforcing mesh with lid, access cover and inlet fitting Burial depth of the tank lid is restricted to 0 mm	2050 L 2300 L 2800 L 4000 L 5200 L 7100 L 8500 L 10,000 L 20,000 L
Combined Septic Tank/ Collection Well	Vertical axis type precast concrete with steel reinforcing mesh Certification applies only to the construction of the tank, it does not include the lid and any internal fittings such as partitions	2300L/4600L 3050L/4050L
Pump well	Vertical axis type precast concrete with steel reinforcing mesh, with lid, access cover and inlet fitting	900 L 2000 L



Central Coast Septics Pty. Ltd.

ABN 63 000 605 069

Registered Office;
5 Marklea Close
Tuggerah NSW 2259
PO Box 245
Wyong NSW 2259
Ph; (02) 4352 2154

Certified Product
AS/NZS 1546.1:2008
Registration Number:
464

MANUFACTURERS OF SEPTIC TANKS AND COLLECTION WELLS email;info@centralcoastseptics.com.au

SPECIFICATIONS;

- BASE;** 80mm thick reinforced with one layer of SL72 reinforcement complying AS/NZS 4671
- LID;** 80mm thick reinforced with SL72 bottom plus N12 trimmer bars sitting on top of SL72. This lid has not been designed to carry fill or other surcharge loading apart from pedestrain traffic.
- CONCRETE COVER;** As per AS/NZS 1546-1;2008 minimum concrete cover is to be 20mm.
- CAPACITY; Single Tank - Septic**

Combined Collection Well Capacity
7100 litres

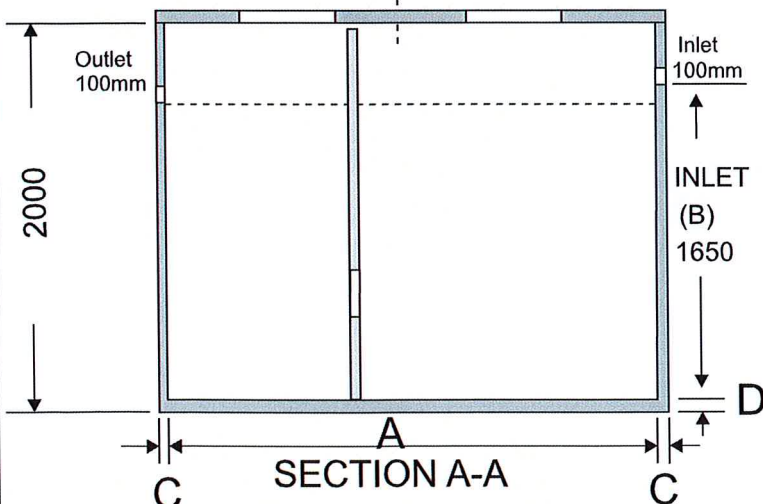
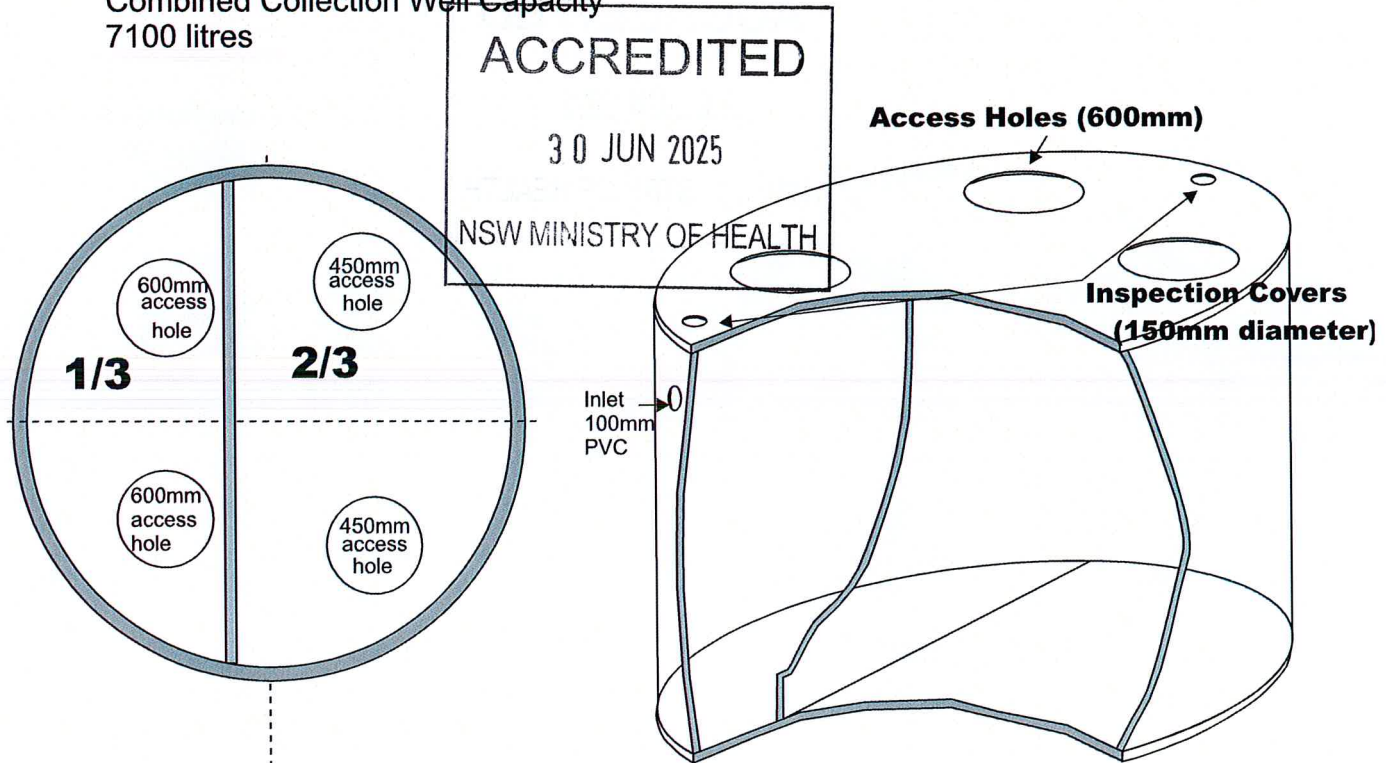

Partitions located accordingly

(A) mm	(B) mm	(C) mm	(D) mm	CAPACITY Litres
2400	1650	50	80	7100

INSTALLATION;

**NOTE THAT THE TANK IS TO BE
FOUNDED ON A BED OF UNIFORMLY COMPACTED
AND LEVELLED SAND AT LEAST 100MM THICK.**



Certified Product
AS/NZS 1546.1:2008
Registration Number:
464

Central Coast Septics Pty. Ltd.

ABN 63 000 605 069

MANUFACTURERS OF SEPTIC TANKS AND COLLECTION WELLS email:info@centralcoastseptics.com.au

Registered Office;
5 Marklea Close
Tuggerah NSW 2259
PO Box 245
Wyong NSW 2259
Ph; (02) 4352 2154

SPECIFICATIONS;

BASE; 80mm thick reinforced with one layer of SL72 reinforcement complying AS/NZS 4671

LID; 80mm thick reinforced with SL72 bottom plus N12 trimmer bars sitting on top of SL72.
This lid has not been designed to carry fill or other surcharge loading apart from pedestrain traffic.

CONCRETE

COVER; As per **AS/NZS 1546-1;2008** minimum concrete cover is to be 20mm.

Combined Collection Well Capacity
7100 litres

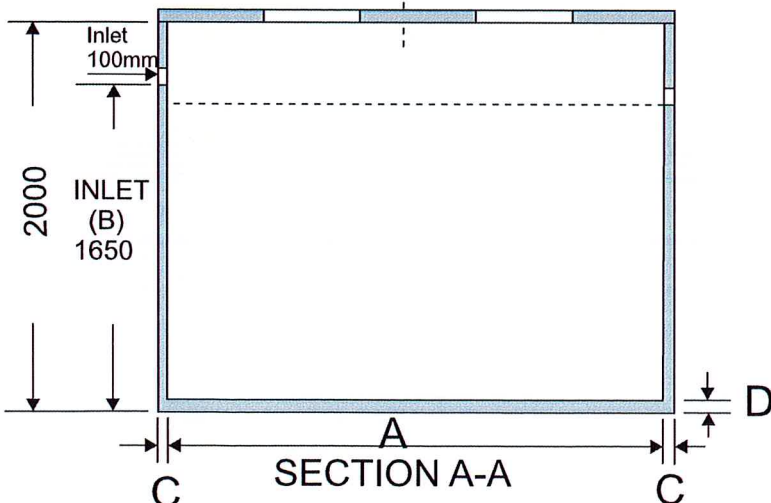
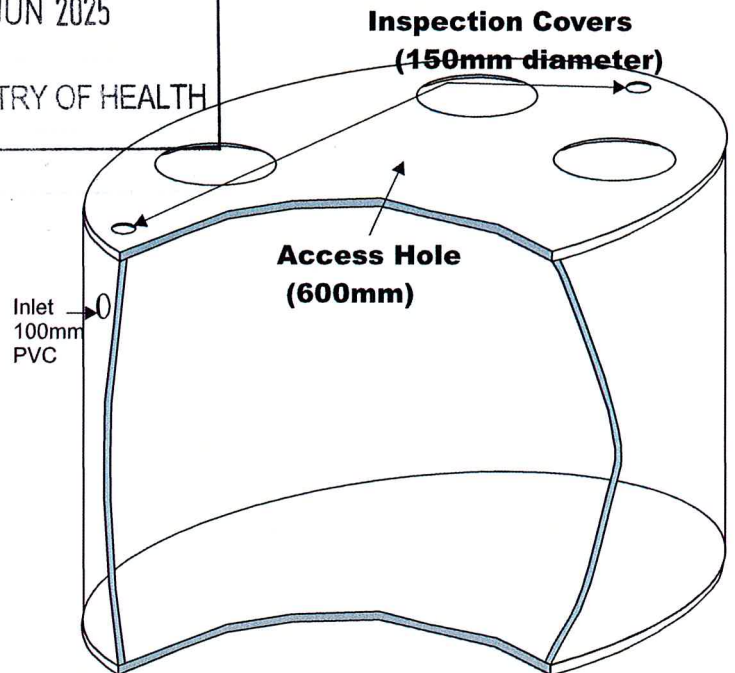
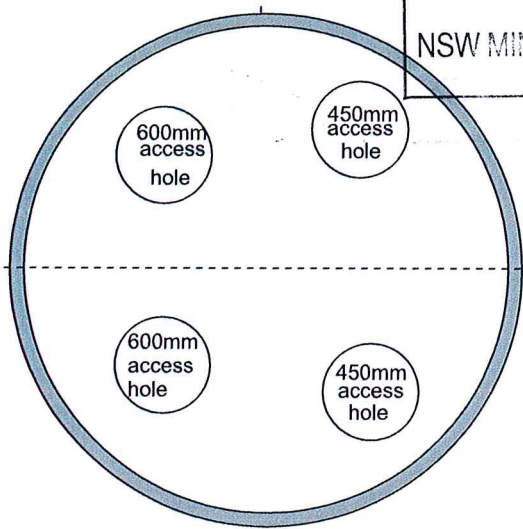
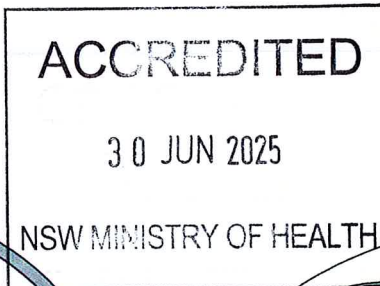

COLLECTION WELL

(A) mm	(B) mm	(C) mm	(D) mm	CAPACITY Litres
2400	1650	50	80	7100

INSTALLATION;

**NOTE THAT THE TANK IS TO BE
FOUNDED ON A BED OF UNIFORMLY COMPACTED
AND LEVELLED SAND AT LEAST 100MM THICK.**



Central Coast Septics Pty. Ltd.

ABN 63 000 605 069

Registered Office;
5 Marklea Close
Tuggerah NSW 2259
PO Box 245
Wyong NSW 2259
Ph; (02) 4352 2154

Certified Product
AS/NZS 1546.1:2008
Registration Number:
464

MANUFACTURERS OF SEPTIC TANKS AND COLLECTION WELLS email;info@centralcoastseptics.com.au

SPECIFICATIONS;

BASE; 80mm thick reinforced with one layer of SL72 reinforcement complying AS/NZS 4671

LID; 80mm thick reinforced with SL72 bottom plus N12 trimmer bars sitting on top of SL72.
This lid has not been designed to carry fill or other surcharge loading apart from pedestrain traffic.

CONCRETE

COVER; As per **AS/NZS 1546-1;2008** minimum concrete cover is to be 20mm.

Combined Collection Well Capacity
7100 litres
8500 litres

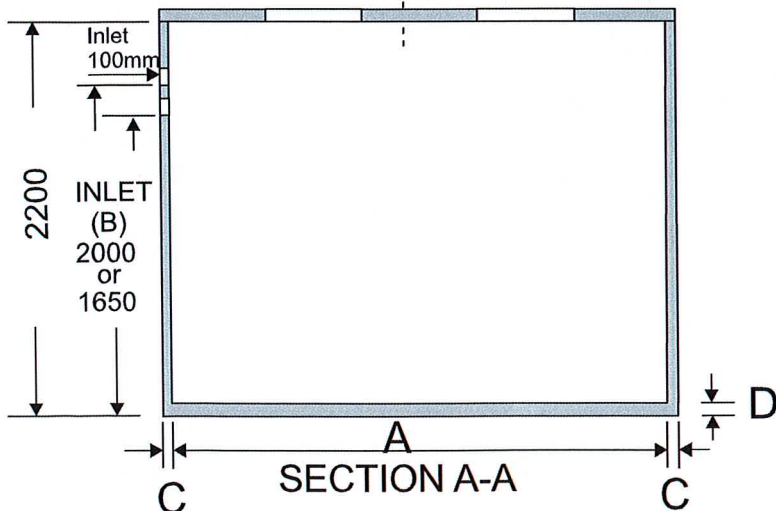
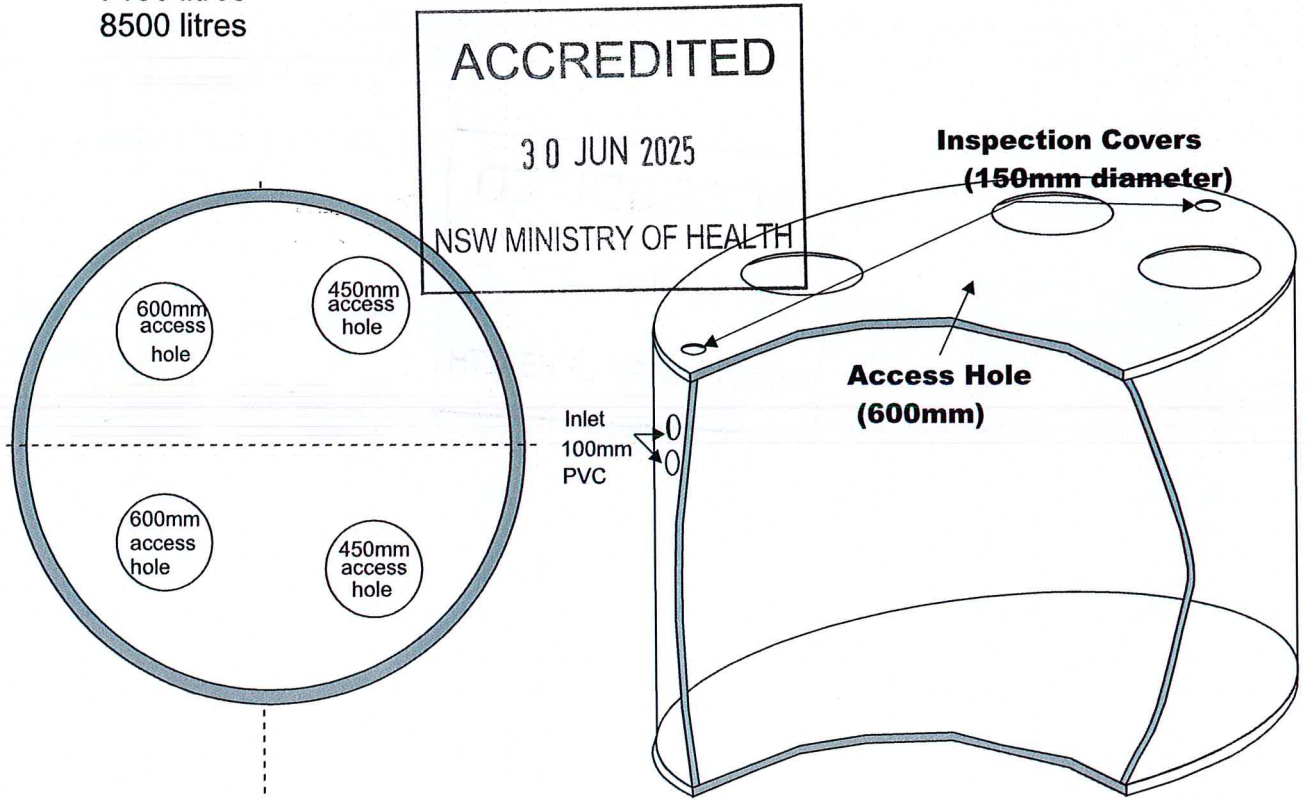

COLLECTION WELL

(A) mm	(B) mm	(C) mm	(D) mm	CAPACITY Litres
2400	2000	50	80	8500
2400	1650	50	80	7100

INSTALLATION;

**NOTE THAT THE TANK IS TO BE
FOUNDED ON A BED OF UNIFORMLY COMPACTED
AND LEVELLED SAND AT LEAST 100MM THICK.**



Central Coast Septics Pty. Ltd.

ABN 63 000 605 069

Registered Office;
5 Marklea Close
Tuggerah NSW 2259
PO Box 245
Wyong NSW 2259
Ph; (02) 4352 2154

Certified Product
AS/NZS 1546.1:2008
Registration Number:
464

MANUFACTURES OF SEPTIC TANKS AND COLLECTION WELLS email:info@centralcoastseptics.com.au

SPECIFICATIONS;

BASE; 80mm thick reinforced with one layer of SL72 reinforcement complying AS/NZS 4671

LID; 80mm thick reinforced with SL72 bottom plus N12 trimmer bars sitting on top of SL72.
This lid has not been designed to carry fill or other surcharge loading apart from pedestrain traffic.

CONCRETE

COVER; As per AS/NZS 1546-1;2008 minimum concrete cover is to be 20mm.

CAPACITY; Single Tank Septic/Collection

1-5 person capacity;- SEPTIC (2300)- COLLECTION WELL (4600 litres)

6-10 person capacity;- SEPTIC (3050)- COLLECTION WELL (4050 litres)

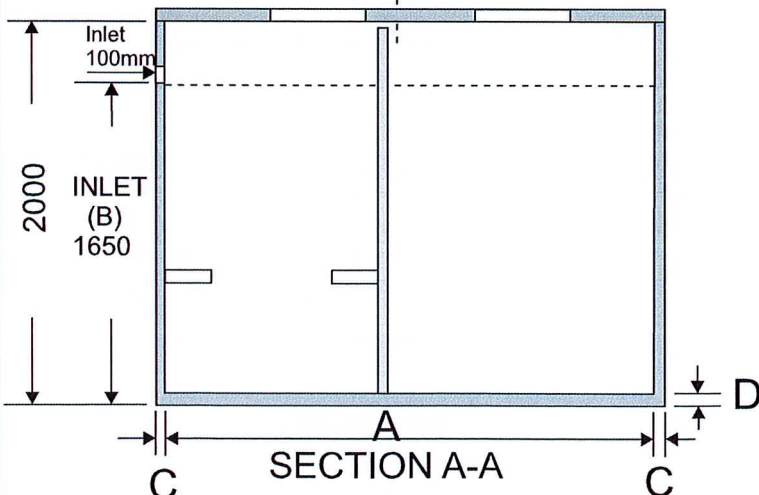
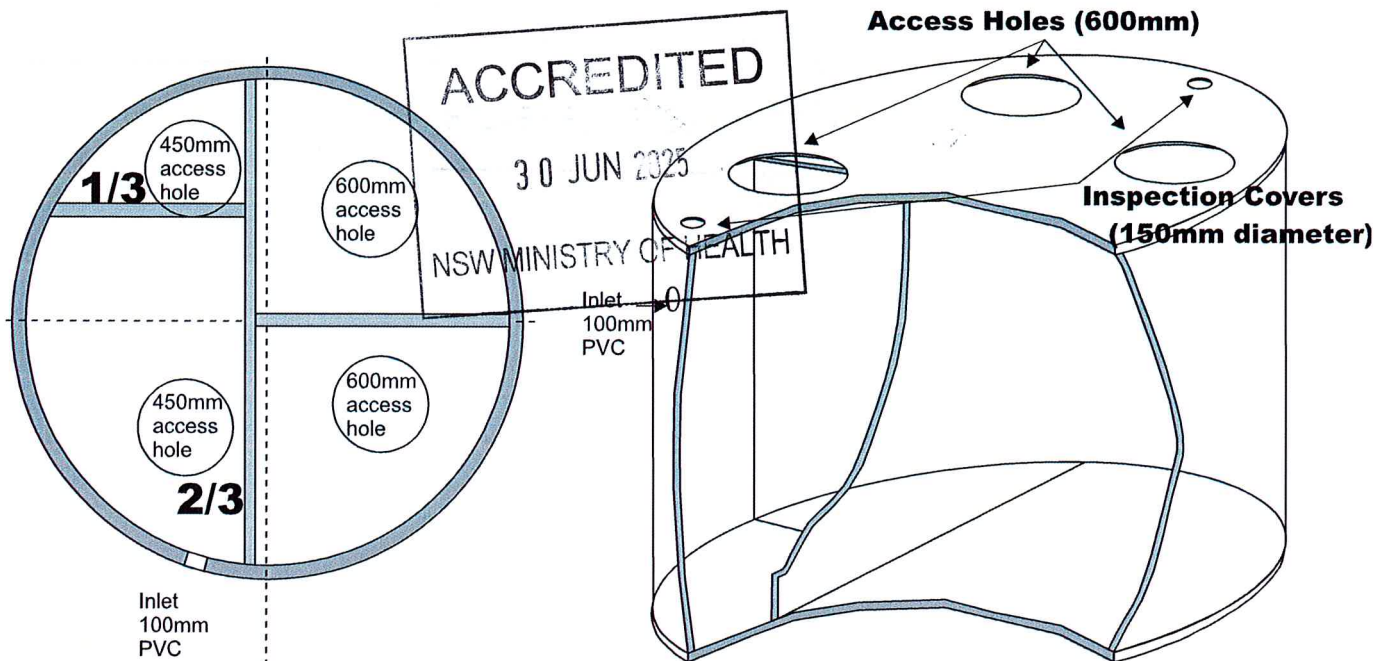

Partitions located accordingly

(A) mm	(B) mm	(C) mm	(D) mm	CAPACITY Litres
2400	1650	50	80	7100

INSTALLATION;

**NOTE THAT THE TANK IS TO BE
FOUNDED ON A BED OF UNIFORMLY COMPACTED
AND LEVELLED SAND AT LEAST 100MM THICK.**



Central Coast Septics Pty. Ltd.

ABN 63 000 605 069

Registered Office;
5 Marklea Close
Tuggerah NSW 2259
PO Box 245
Wyong NSW 2259
Ph; (02) 4352 2154

Certified Product
AS/NZS 1546.1:2008
Registration Number:
464

MANUFACTURERS OF SEPTIC TANKS AND COLLECTION WELLS email;info@centralcoastseptics.com.au

SPECIFICATIONS;

BASE; 80mm thick reinforced with one layer of SL72 reinforcement complying AS/NZS 4671

LID; 120mm thick reinforced with SL72 bottom plus N12 trimmer bars sitting on top of SL72.
This lid has not been designed to carry fill or other surcharge loading apart from pedestrain traffic.

CONCRETE

COVER; As per **AS/NZS 1546-1;2008** minimum concrete cover is to be 20mm.

Combined Collection Well Capacity
10,000 litres

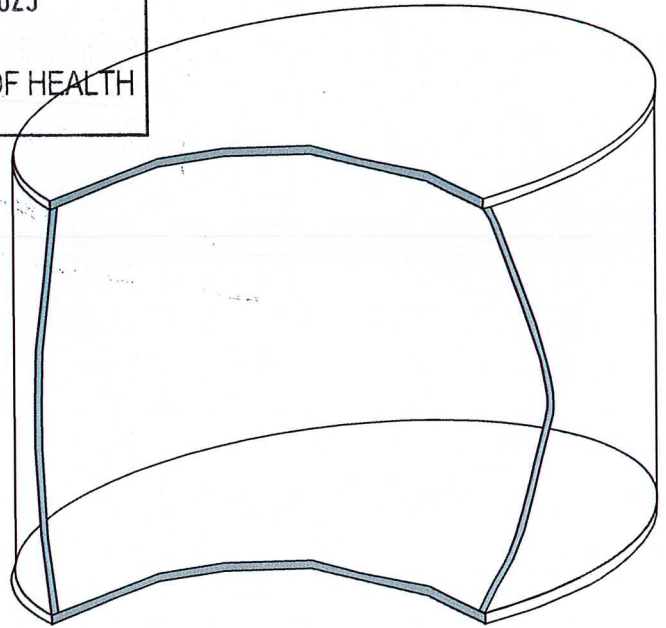
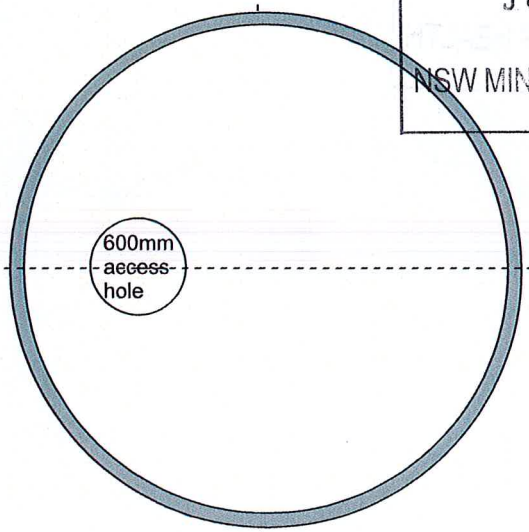

COLLECTION WELL

(A) mm	(B) mm	(C) mm	(D) mm	CAPACITY Litres
2450	2320	50	80	10,000

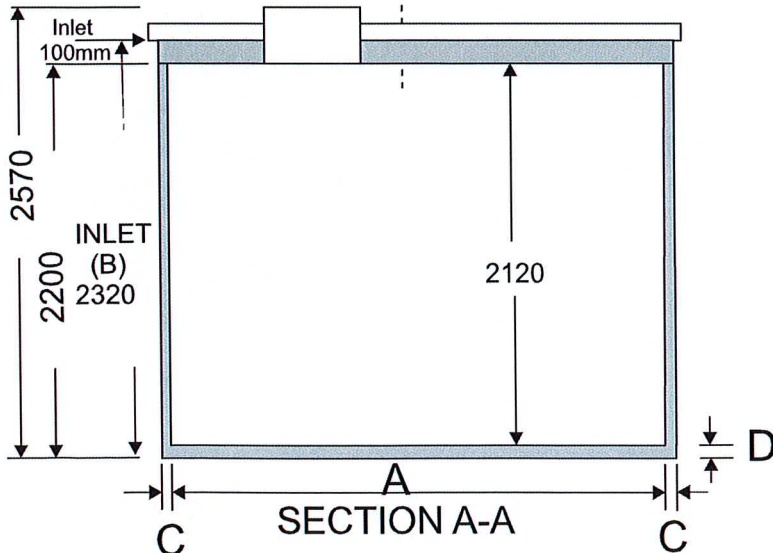

INSTALLATION;

**NOTE THAT THE TANK IS TO BE
FOUNDED ON A BED OF UNIFORMLY COMPACTED
AND LEVELLED SAND AT LEAST 100MM THICK.**



Central Coast Septics Pty. Ltd.

ABN 63 000 605 069

Registered Office;
5 Marklea Close
Tuggerah NSW 2259
PO Box 245
Wyong NSW 2259
Ph; (02) 4352 2154

Certified Product
AS/NZS 1546.1:2008
Registration Number:
464

MANUFACTURES OF SEPTIC TANKS AND COLLECTION WELLS email:info@centralcoastseptics.com.au

SPECIFICATIONS;

BASE; 80mm thick reinforced with one layer of SL72 reinforcement complying AS/NZS 4671

LID; 120mm thick reinforced with SL72 bottom plus N12 trimmer bars sitting on top of SL72.
This lid has not been designed to carry fill or other surcharge loading apart from pedestrain traffic.

CONCRETE

COVER; As per **AS/NZS 1546-1;2008** minimum concrete cover is to be 20mm.

Combined Collection Well Capacity
5,200 litres

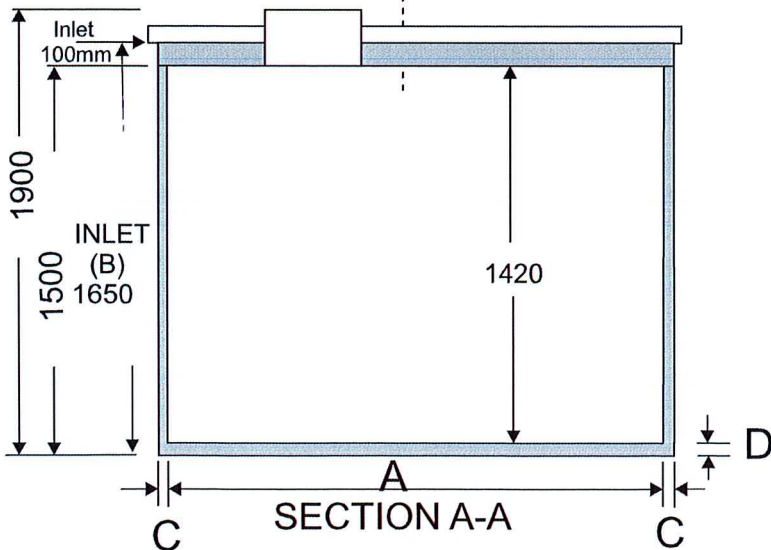
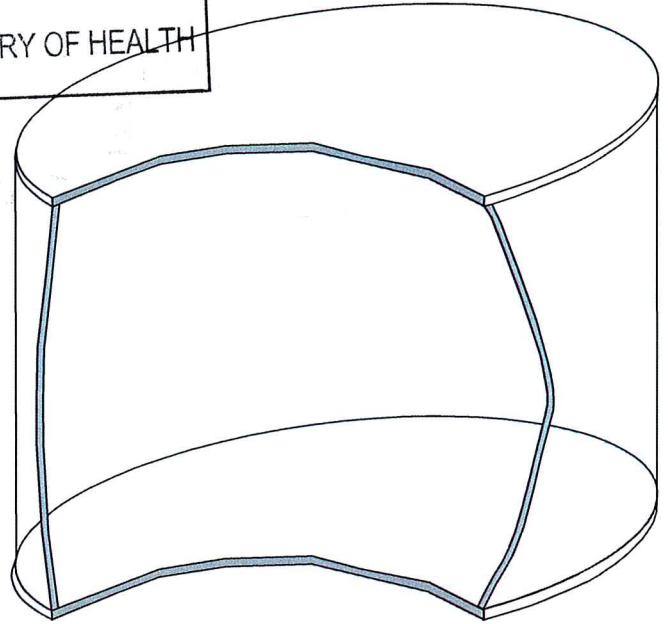
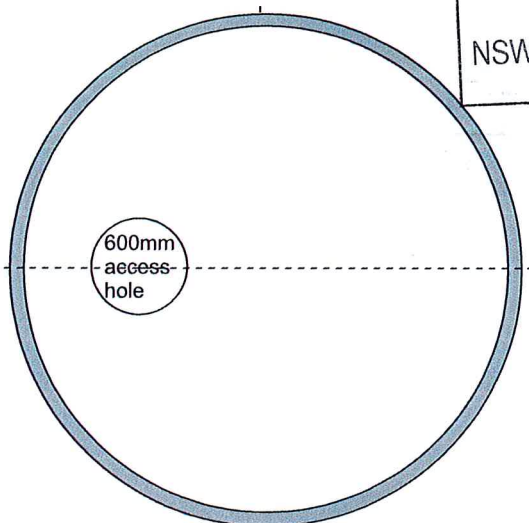
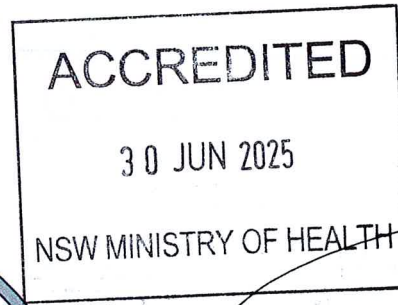

COLLECTION WELL

(A) mm	(B) mm	(C) mm	(D) mm	CAPACITY Litres
2150	1650	50	80	5,200

INSTALLATION;

**NOTE THAT THE TANK IS TO BE
FOUNDED ON A BED OF UNIFORMLY COMPACTED
AND LEVELLED SAND AT LEAST 100MM THICK.**



Central Coast Septics Pty. Ltd.

ABN 63 000 605 069

Registered Office;
5 Marklea Close
Tuggerah NSW 2259
PO Box 245
Wyong NSW 2259
Ph; (02) 4352 2154

Certified Product
AS/NZS 1546.1:2008
Registration Number:
464

MANUFACTURERS OF SEPTIC TANKS AND COLLECTION WELLS email;info@centralcoastseptics.com.au

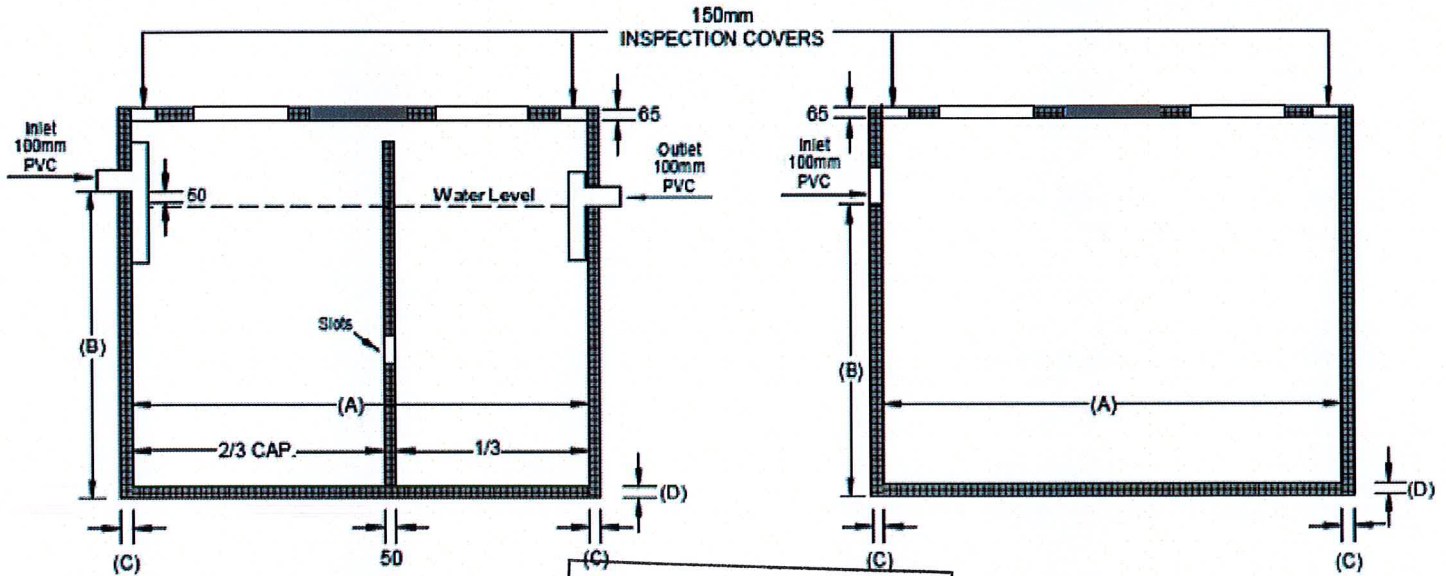

SEPTIC TANK				
A	B	C	D	LITRES
1650	1200	50	65	2300
1830	1220	50	65	2800
1970	1440	50	65	4000

Capacity table in millimetres

OVERALL	
HEIGHT	DIAMETER
1605	1750
1605	1750
1605	1935
1818	2070

COLLECTION WELL				
A	B	C	D	LITRES
1650	1065	50	65	2050
1650	1150	50	65	2300
1830	1170	50	65	2800
1970	1390	50	65	4000

Capacity table in millimetres

SPECIFICATIONS:

- *Reinforcement comply with **AS/NZS 4671**
- *Partition wall only in septic tanks over 2050 litres.
- *Concrete minimum compressive strength 32 MPA -- 28 days reinforced with steel mesh for base, walls and lids.
- *The lid has not been designed to carry fill or any other surcharge loading apart from pedestrian.
- *Tanks comply with **AS/NZS 1546-1:2008**



Central Coast Septics Pty. Ltd.

ABN 63 000 605 069

Registered Office;
5 Marklea Close
Tuggerah NSW 2259
PO Box 245
Wyong NSW 2259
Ph; (02) 4352 2154

Certified Product
AS/NZS 1546.1:2008
Registration Number:
464

MANUFACTURES OF SEPTIC TANKS AND COLLECTION WELLS email;info@centralcoastseptics.com.au

Tank Manufacture; Central Coast Septics P/L
Single Tank Collection Well / Lid
AS/NZS 1546.1

SPECIFICATIONS

BASE; 65mm thick reinforced with steel fibre
as per AS/NZ 1546.1:2008

LID; 120mm thick reinforced with steel fibre
as per AS/NZ 1546.1:2008
This lid has been designed to carry fill or
pedestrian traffic.

CONCRETE COVER; As per AS/NZS 1546.1 minimum
concrete cover is to be 20mm

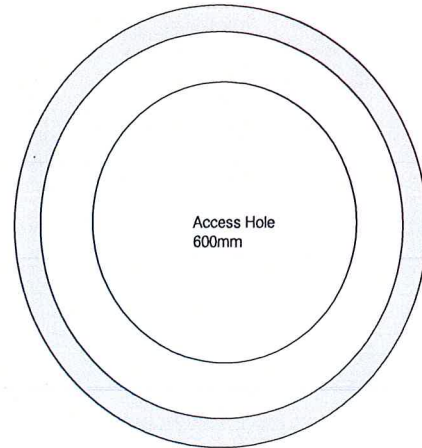

INSTALLATION

NOTE that the tank is to be
found on a bed of uniformly
compacted and levelled sand
at least 100mm thick

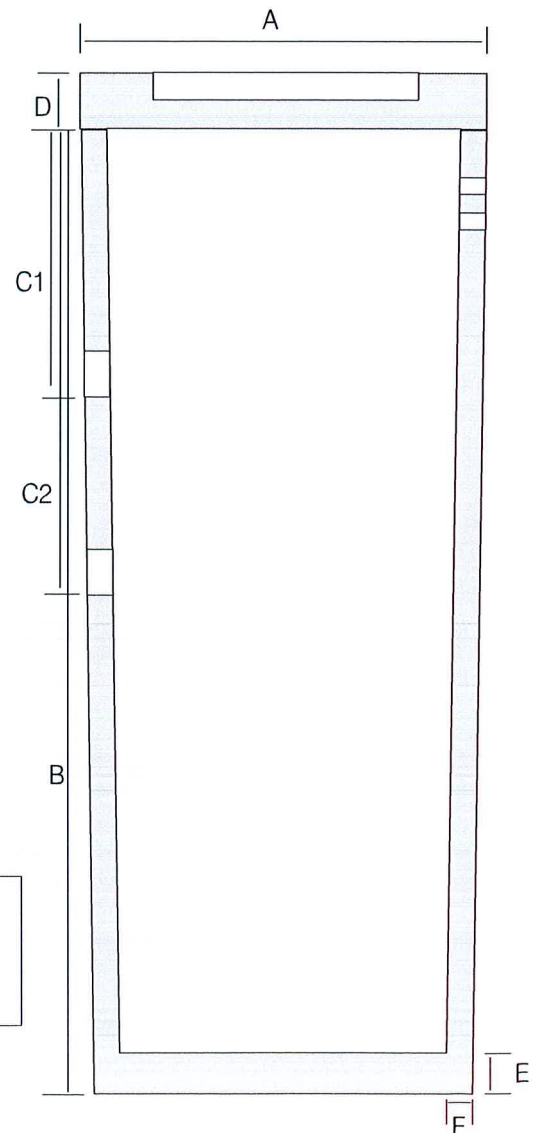

CAPACITY	A	B	C1	C2	D	E	F
Es900	935mm	2065mm	575	995	120	65	60



Central Coast Septics Pty. Ltd.

ABN 63 000 605 069

Registered Office;
5 Marklea Close
Tuggerah NSW 2259
PO Box 245
Wyong NSW 2259
Ph; (02) 4352 2154

Certified Product
AS/NZS 1546.1:2008
Registration Number:
464

MANUFACTURES OF SEPTIC TANKS AND COLLECTION WELLS email:info@centralcoastseptics.com.au

SPECIFICATIONS

BASE: 100mm thick reinforced with two layers of N12-200 MESH reinforcement complying **AS/NS 4671**
LID: 150mm thick reinforced with N10-150 bottom plus N12 trimmer bars sitting on top of N10-150 MESH
 This lid has been designed to carry a maximum loading of 500kg

CONCRETE:

COVER: As per **AS/NZ 1546-1;2008** minimum concrete cover is to be 30mm

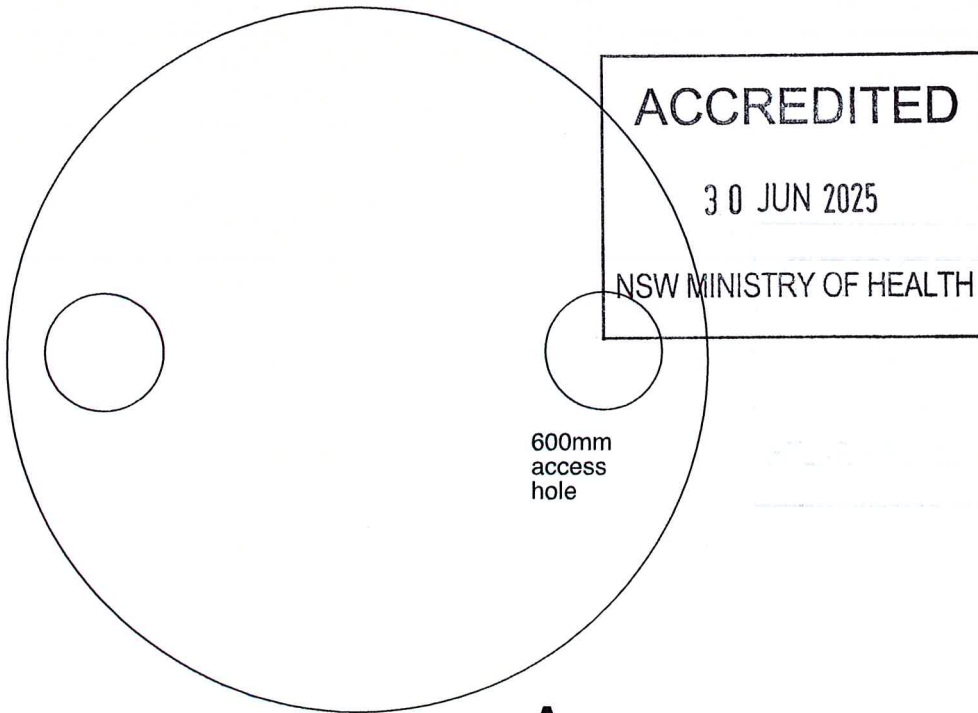

Collection Well Capacity
20,000 litres

A	2980mm
B	3250mm
C	3050mm
D	80mm
E	100mm
F	150mm

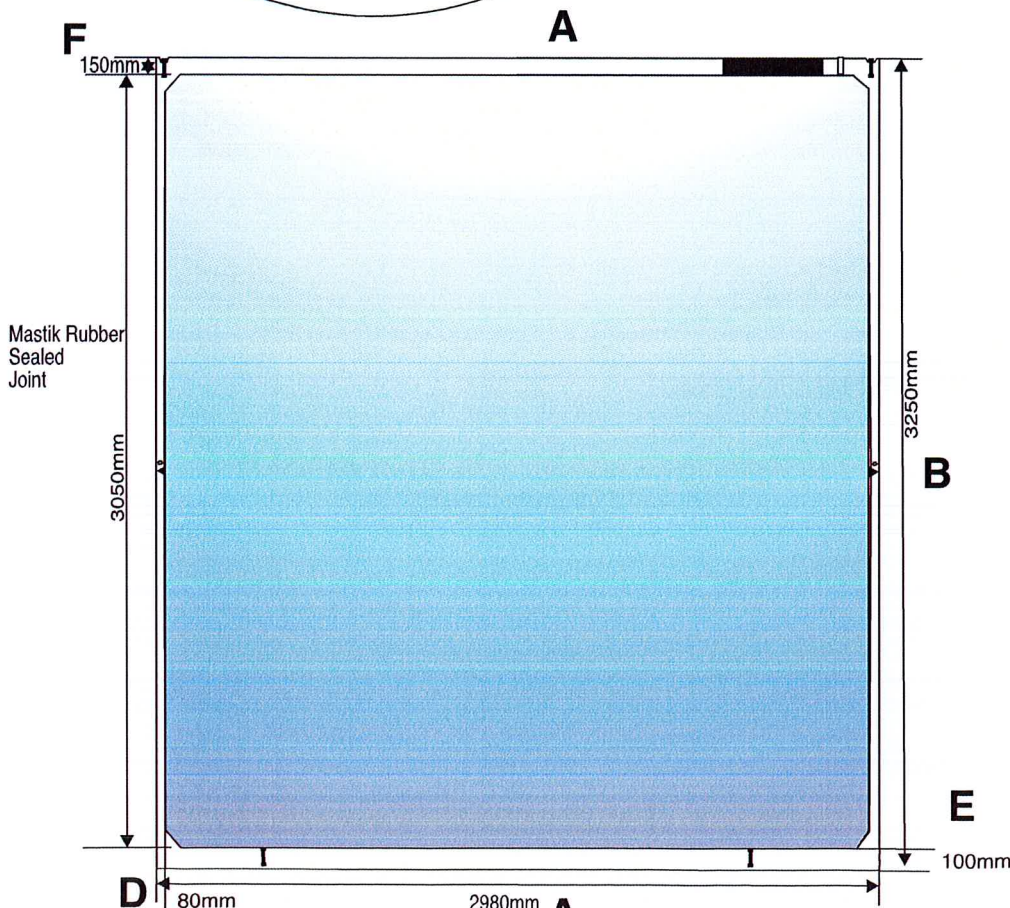

INSTALLATION

NOTE THAT THE TANK IS TO BE
FOUNDED ON A OF UNIFORMLY
COMPACTED AND LEVELLED
SAND AT LEAST 100MM THICK.

Hole Excavation

4.0 x 4.0 x 3.2 deep

Above Ground

4.0 x 4.0

level crusher dust

base